

# HITACHI

БЪЛГАРСКИ

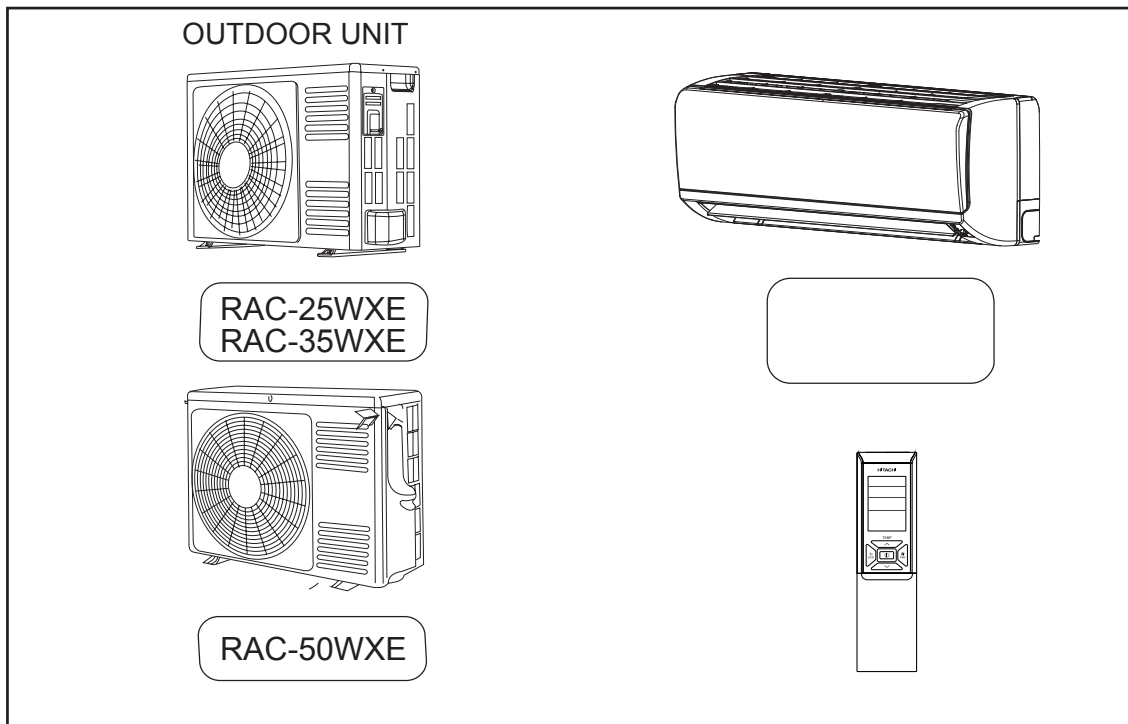







## Ръководство за употреба Стр. 1~36

За да осигурите най-висока ефективност и години на безаварийна употреба, моля прочете цялото ръководство за употреба.







- Моля, прочетете "инструкцията за безопасност" внимателно, преди да използвате уреда.
- Обърнете специално внимание на знаците ▲ "Внимание"▲▲"Предупреждение"  
Раздела съдържа инструкции, които, ако не се спазват стриктно, могат да причинят смърт или сериозно нараняване. Раздела "Внимание" съдържа въпроси, които могат да доведат до сериозни последици, ако не се наблюдават правилно. Моля, спазвайте всички инструкции стриктно за да се гарантира безопасността.
- Значение на обозначения. (По долу описаниите са само примерни.)











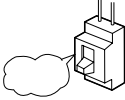



 Този знак означава забрана.	 Показва инструкцията, която е задължителна.
---	---

### ПРЕДУПРЕЖДЕНИЕ ПРИ УПОТРЕБА

	<ul style="list-style-type: none"> <li>• Не се опитвайте да ремонтирате уреда сами. Изтичане на вода, грешка, прекъсване на захранването или дори пожар, могат да бъдат причинени ако се опитвате да ремонтирате сами уреда.</li> </ul>	
	<ul style="list-style-type: none"> <li>• Свържете се с оторизиран сервиз за монтажа на Вашият уред. Изтичане на вода, грешка, прекъсване на захранването или дори пожар, могат да бъдат причинени ако се опитвате да ремонтирате сами уреда.</li> </ul>	
	<ul style="list-style-type: none"> <li>• Заземете кабела. Не оставяйте нулевата фаза на кабела в близост до вода, ел.прекъсвачи, или нулевата фаза на телефонна линия. Неправилното окабеляване може да причини електрически шок.</li> </ul>	 ЗАЗЕМЕТЕ КАБЕЛА
	<ul style="list-style-type: none"> <li>• Уверете се, че използваните тръби са подходящи за фреон R32. В противен случай може да се спукат тръбите или да причините повреда.</li> </ul>	
	<ul style="list-style-type: none"> <li>• Използвайте прекъсвач, според мястото на инсталиране на уреда. Без прекъсвач, има опасност от електрически шок.</li> </ul>	 ЗАБРАНА
	<ul style="list-style-type: none"> <li>• Не инсталирайте уреда в близост до местоположение където има газ. Външното тяло може да се възпламени в случай на изтичане на газ в близост. Тръбите трябва да са добре закрепени през 1 м.</li> </ul>	
	<ul style="list-style-type: none"> <li>• Осигурете добро оттичане на дренажната вода. В случай, на пропуск в кондензната тръба, водни капки от вътрешното или външно тяло може да изтичат по покъщнината и да причини повреда.</li> </ul>	
	<ul style="list-style-type: none"> <li>• Уверете се, че се използва монофазно захранване 230V. Ако използвате друг тип захранване може да причините прегряване на компоненти и повреда на уреда.</li> </ul>	 ЗАБРАНЕНО

### ПРЕДУПРЕЖДЕНИЕ ПРИ ПРЕМЕСТВАНЕ ИЛИ ПОДДРЪЖКА

	<ul style="list-style-type: none"> <li>• Ако усетите нещо не типично (като мирис на пушек), изключете уреда и извадете щепсела или изключете предпазителя. Свържете се с монтажната фирма. Повреда, късо съединение или пожар може да се появи, ако уреда продължи да работи при нетипично поведение.</li> </ul>	 "ИЗКЛЮЧЕНО"
	<ul style="list-style-type: none"> <li>• Свържете се с монтажната организация. Неправилното ремонтиране може да предизвика пожар или късо съединение.</li> </ul>	
	<ul style="list-style-type: none"> <li>• Свържете се с монтажната фирма ако се налага да демонтирате уреда. Пожар или късо съединение може да се предизвика при неправилно преместване.</li> </ul>	
	<ul style="list-style-type: none"> <li>• Избягвайте продължително стоене под въздушната струя.</li> </ul>	 ЗАБРАНЕНО
	<ul style="list-style-type: none"> <li>• Използвайте непрекъснат захранващ кабел, без удължаване. Не включвайте прекалено много други уреди в същият захранващ контакт. Оставете захранващият кабел с по-голяма дължина за да не се усуква или изпъва твърде много. Противното може да предизвика пожар или късо съединение.</li> </ul>	 ЗАБРАНЕНО
	<ul style="list-style-type: none"> <li>• Не: пакетирайте, дърпайте, настъпвайте, нагривайте, поставяйте помежду уреди захранващият кабел. Противното може да доведе до нараняване на кабела. Повреденият кабел може да предизвика пожар или късо съединение.</li> </ul>	 ЗАБРАНЕНО
 ЗАБРАНЕНО	<ul style="list-style-type: none"> <li>• Не вкарвайте предмети като например тънки пръчки в отворите за въздух. Може да се нараните от намиращият се вътре в уреда вентилатор.</li> </ul>	

⚠		
		
		
⚠		
		
		
		
		
	 PROHIBITION	
		
		
		
		
		
		
		

## NAMES AND FUNCTIONS OF EACH PART



## OUTDOOR UNIT

RAC-25WXE  
RAC-35WXE

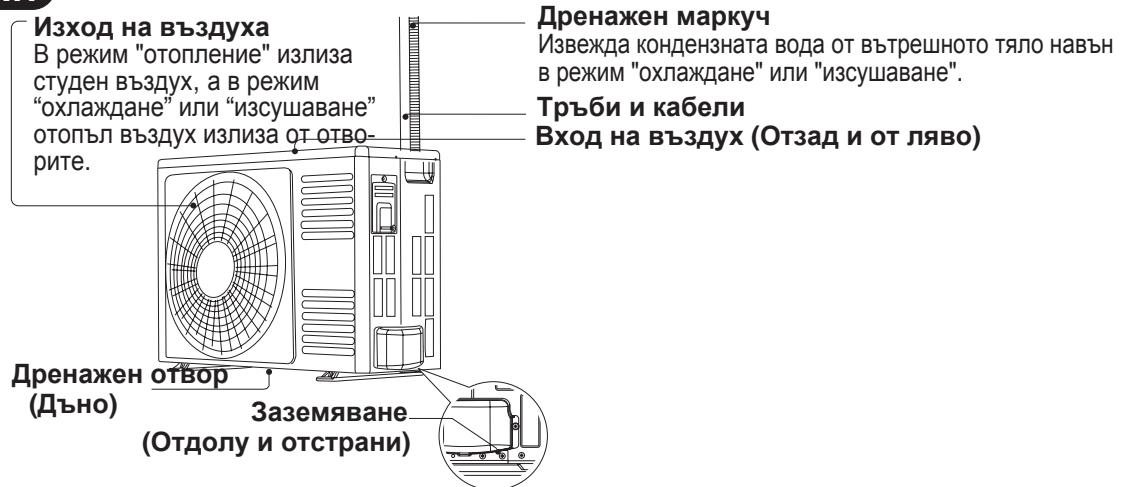

RAC-50WXE



## MODEL NAME AND DIMENSIONS

## NAMES AND FUNCTIONS OF EACH PART

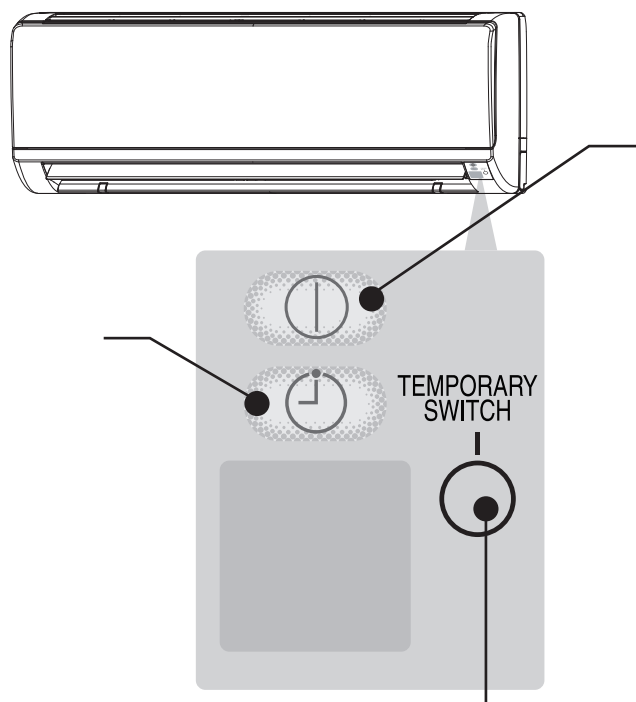

### **ВНИМАНИЕ**

Изключете климатика от контакта или от предпазния бушон, в случай, че няма да го използвате дълго време.

☆

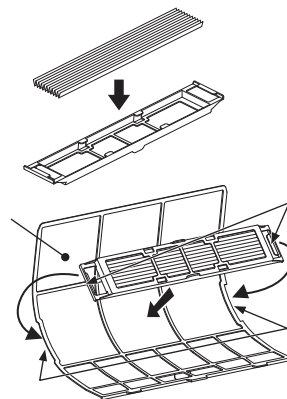

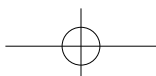
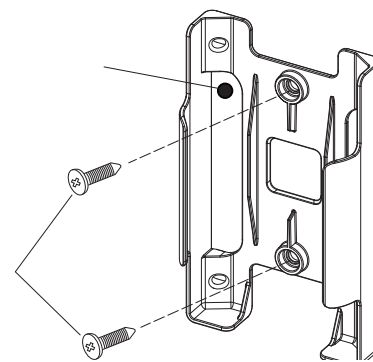
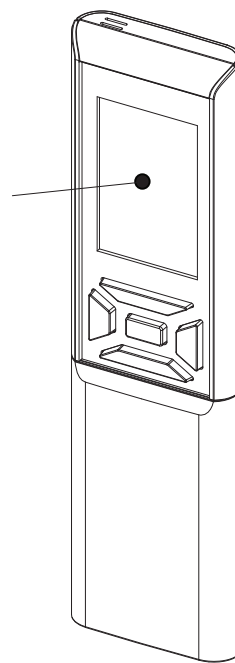
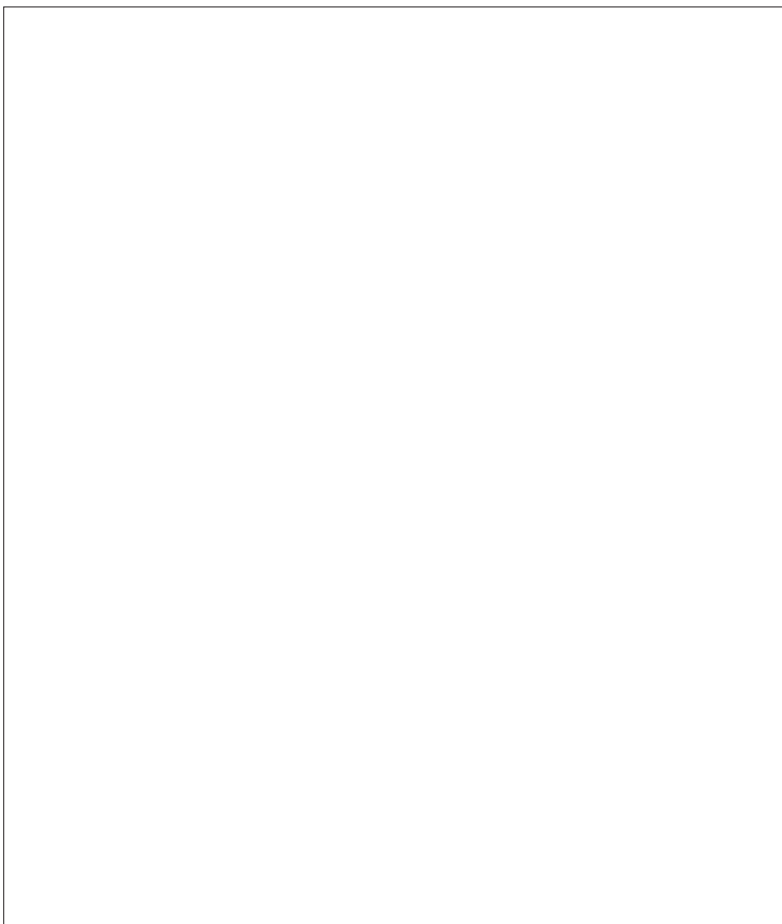
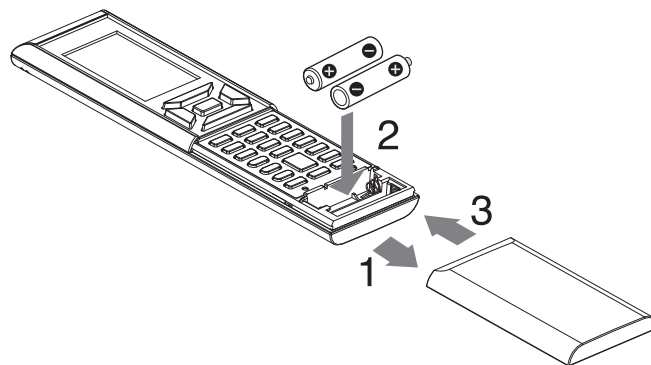
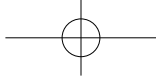

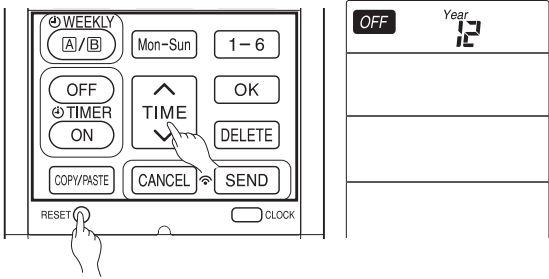

RESET ○



○ CLOCK



○ CLOCK



○ CLOCK

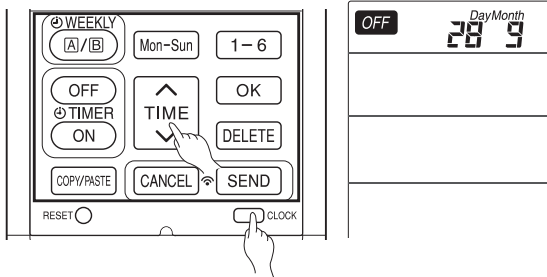

○ CLOCK

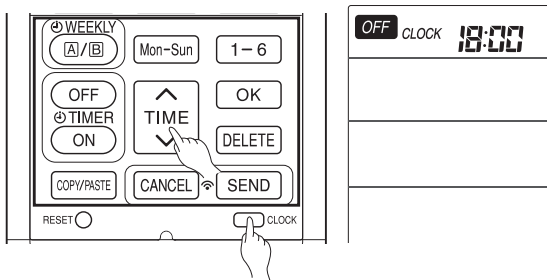

RESET ○

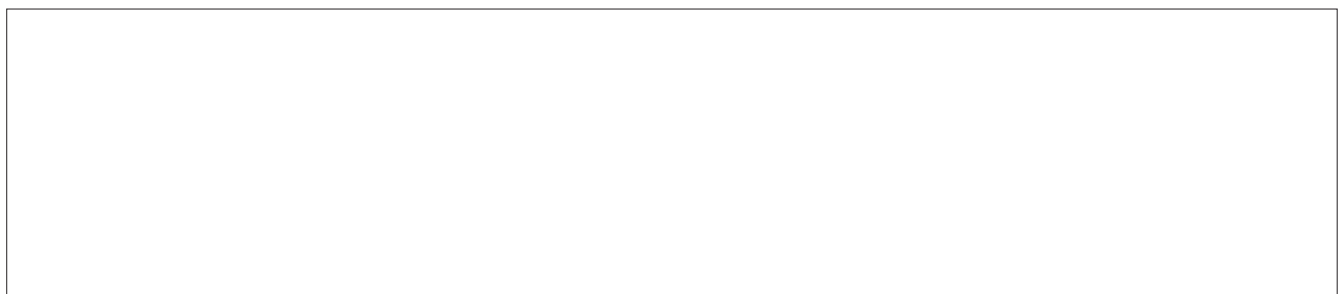
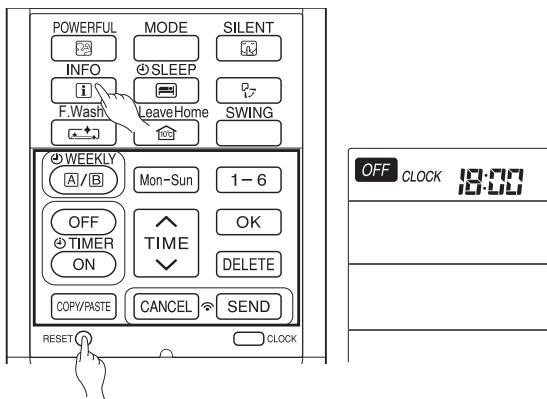

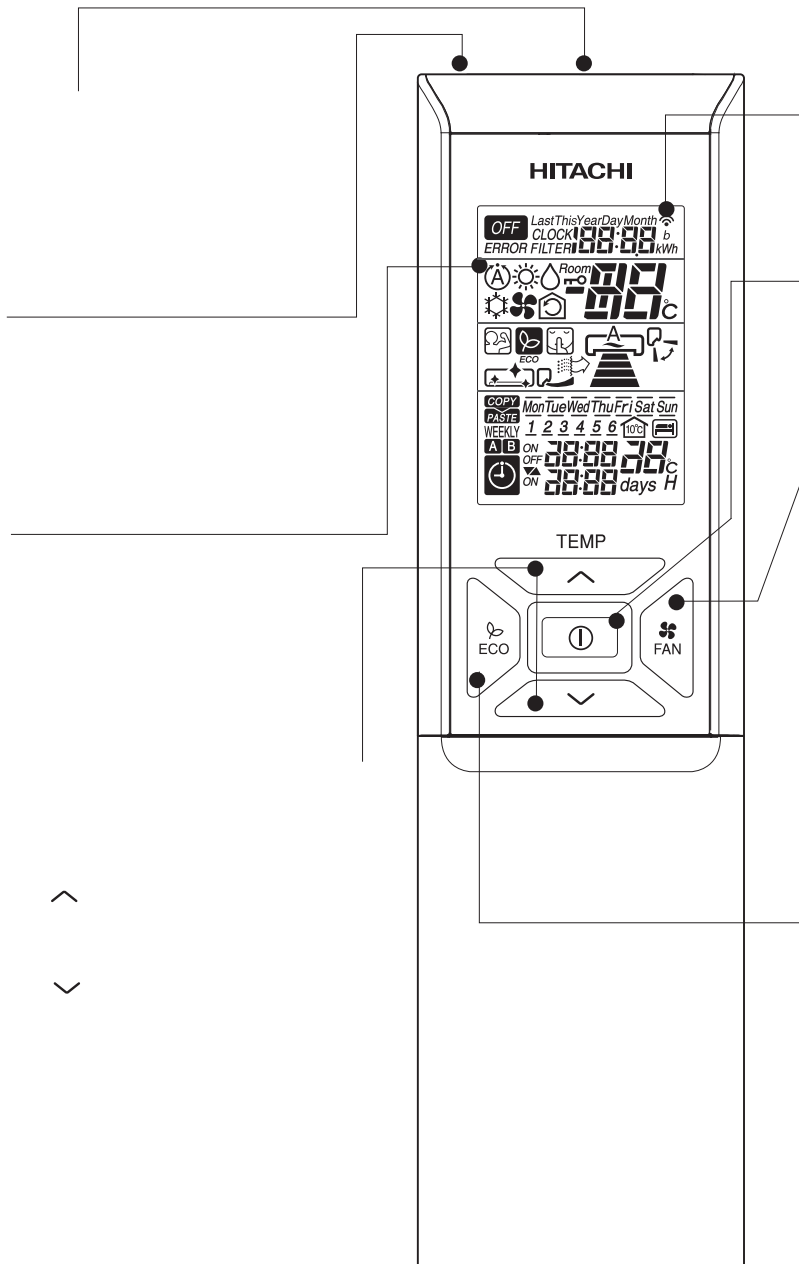



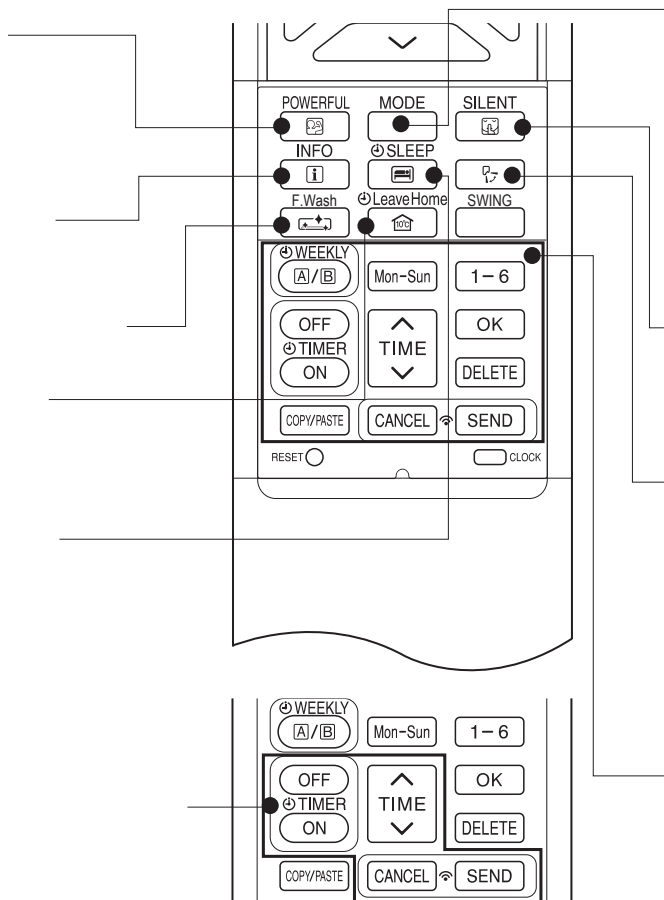

MODE	ИЗБОР НА РЕЖИМ
	АВТО
	ОТОПЛЕНИЕ
	ОБЕЗВЛЪЖНЯВАНЕ
	ОХЛАЖДАНЕ
	ВЕНТИЛАТОР
	СИЛА НА ВЕНТИЛАТОРА
	АВТО
	ТИХ
	СЛАБО СРЕДНО СИЛНО
	СТАРТ / СТОП
	ЕКО

	FAN
Mon-Sun	
1-6	

OFF	
ON	
↑	
TIME	
↓	
OK	
DELETE	
COPY/PASTE	
CANCEL	
SEND	
<input type="checkbox"/>	CLOCK

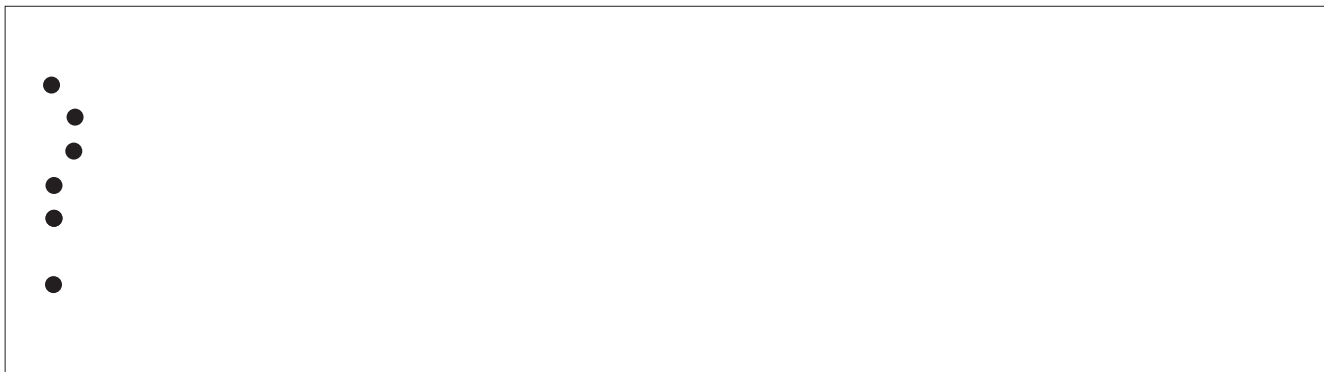

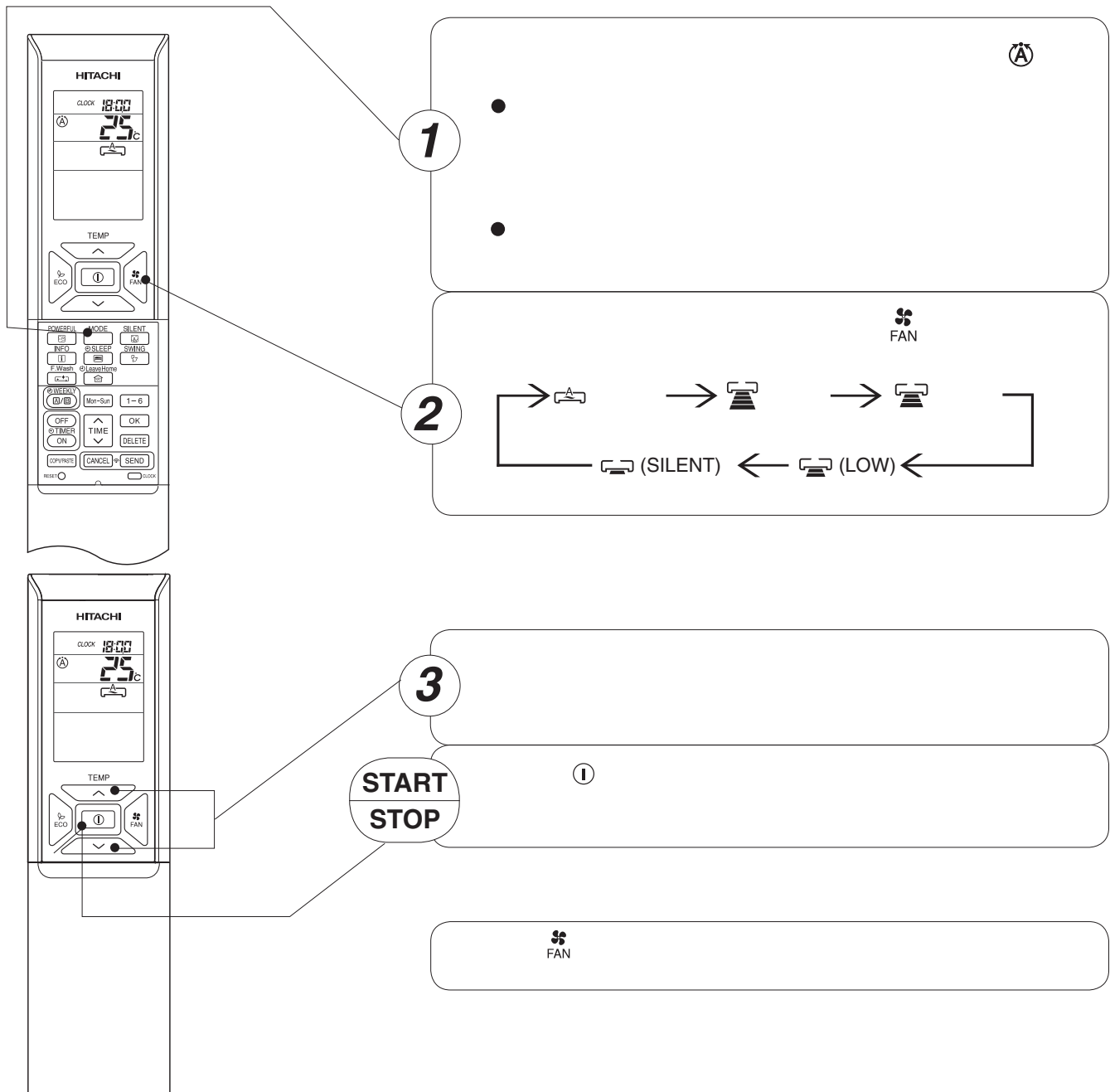

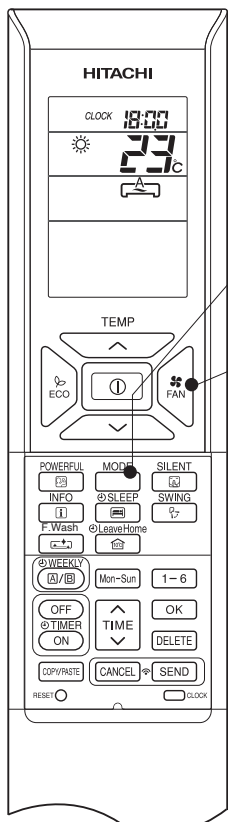

1



2

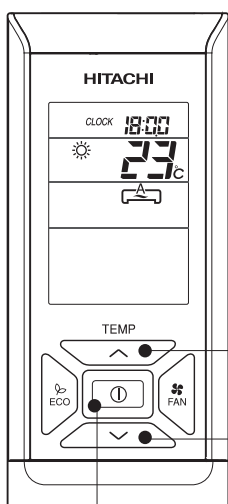
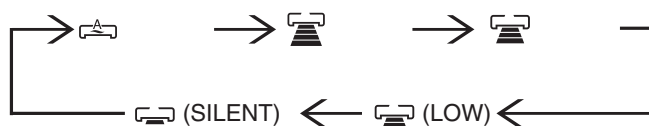

3

START  
STOP



■ Размръзване



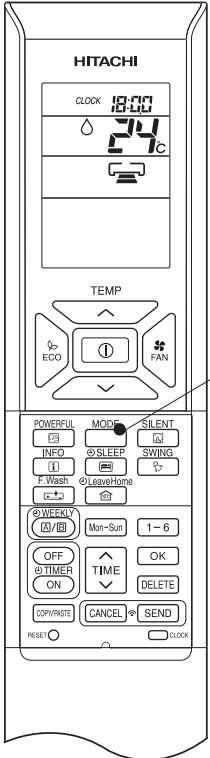

1



2

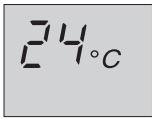

START  
STOP

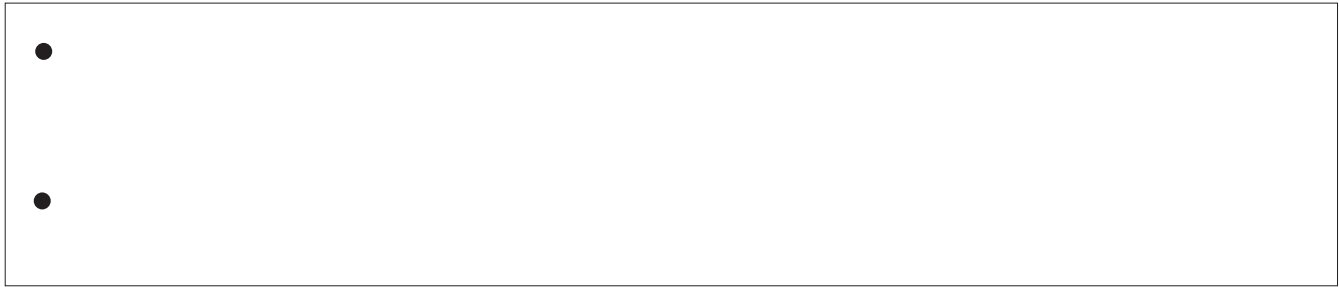
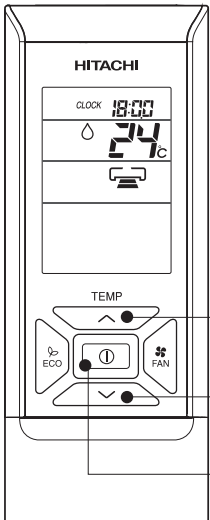

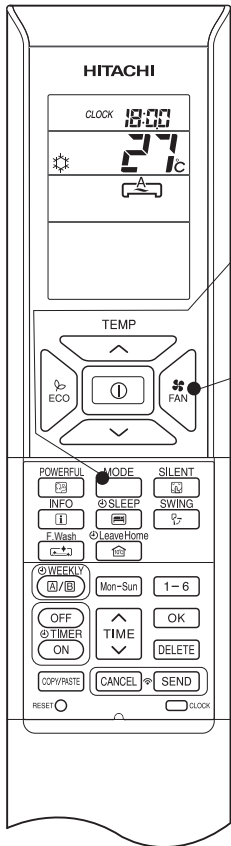

1

2

3

START  
STOP

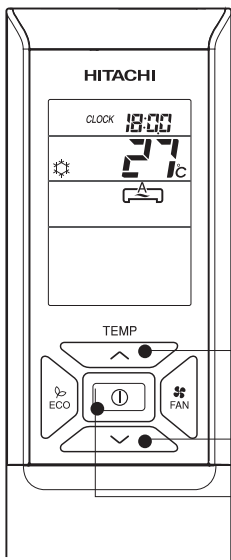
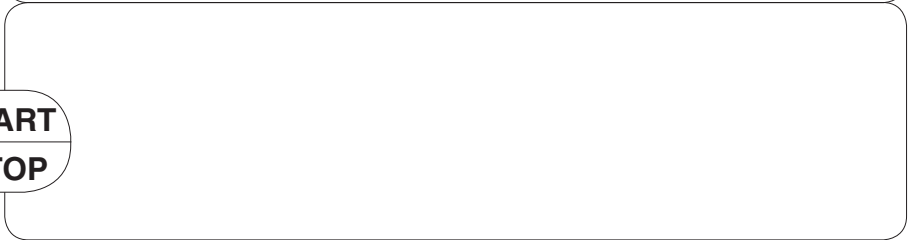
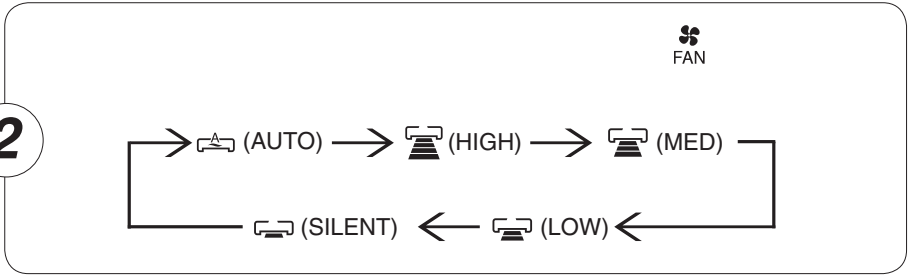

•  
•

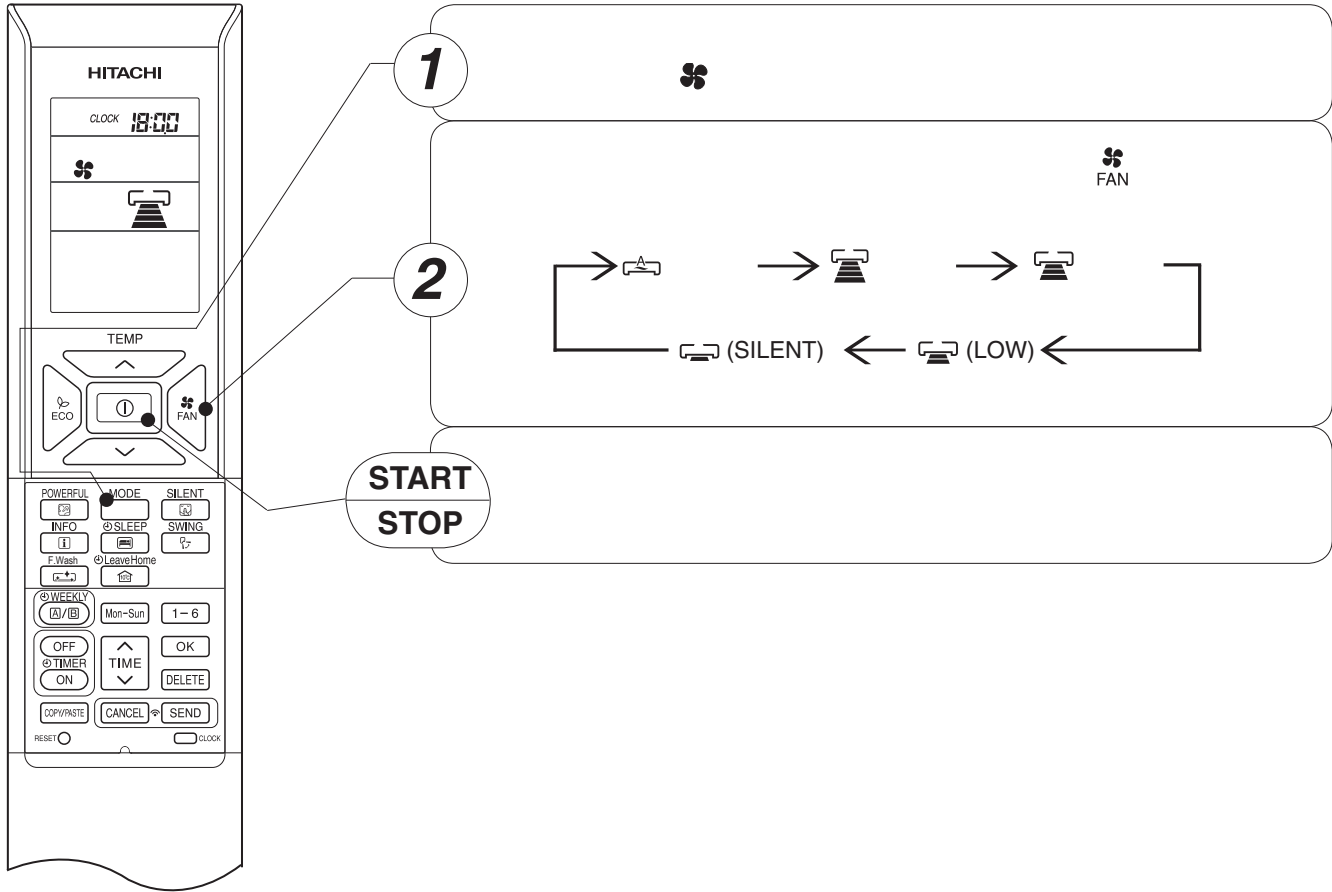



### ■ Старт на вертикално авто люлеене

- 

### ■ Изключване вертикално авто люлеене

- 

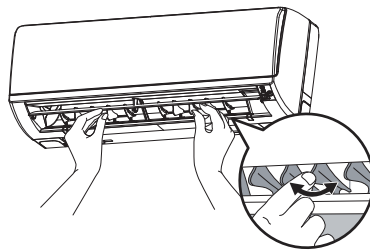
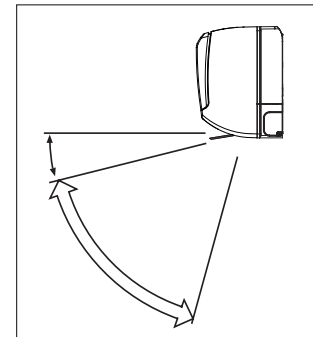
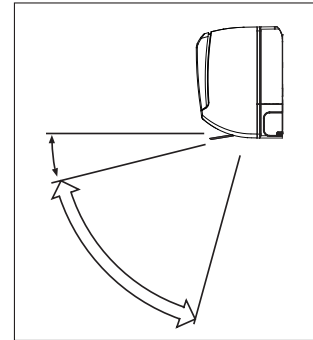
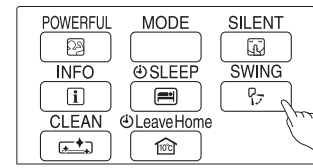
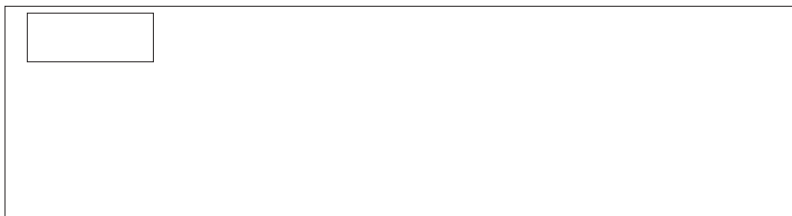
•

1

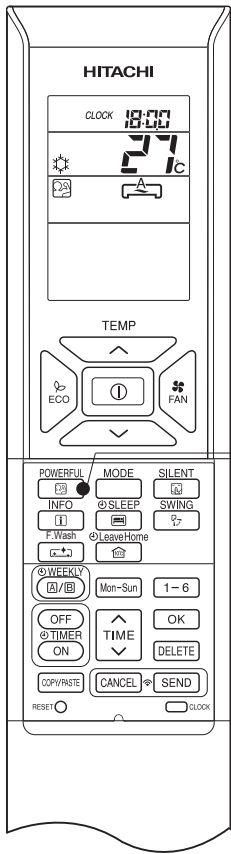



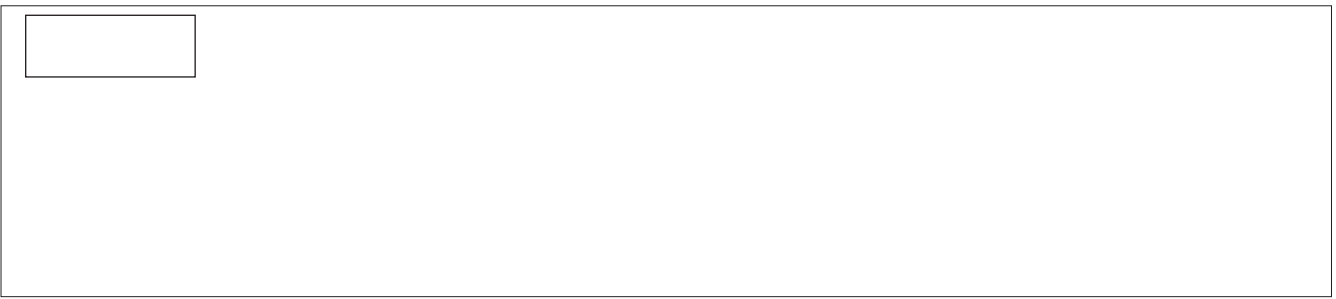
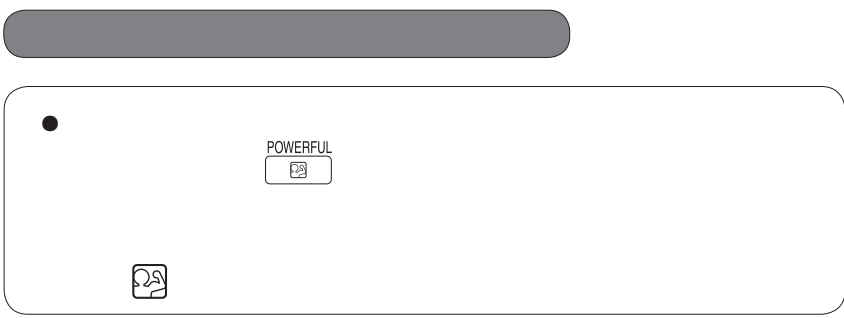
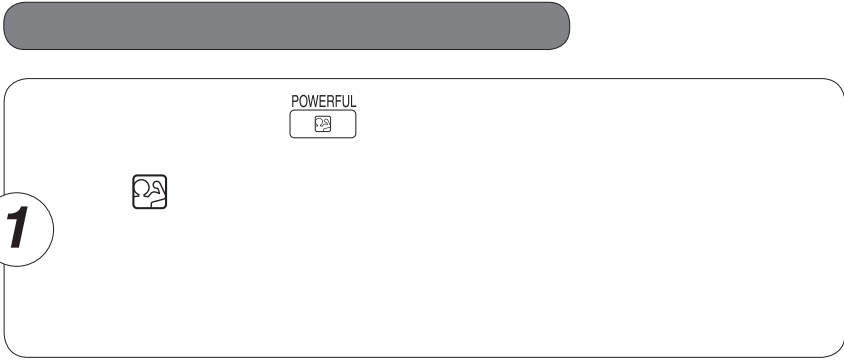

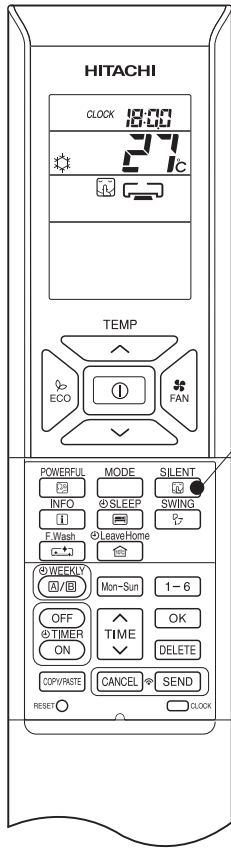
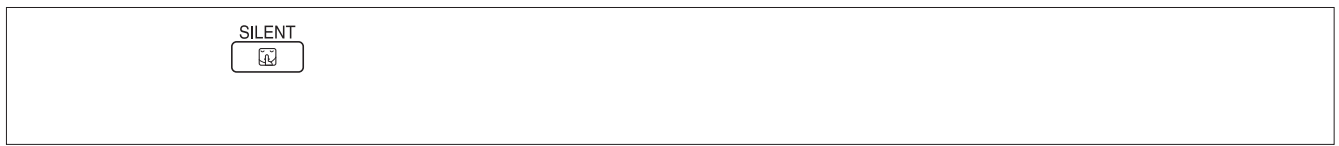
1

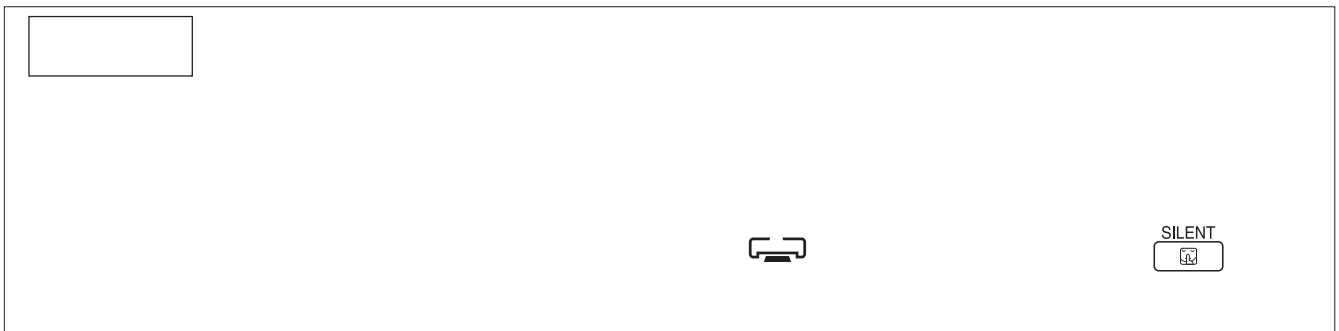
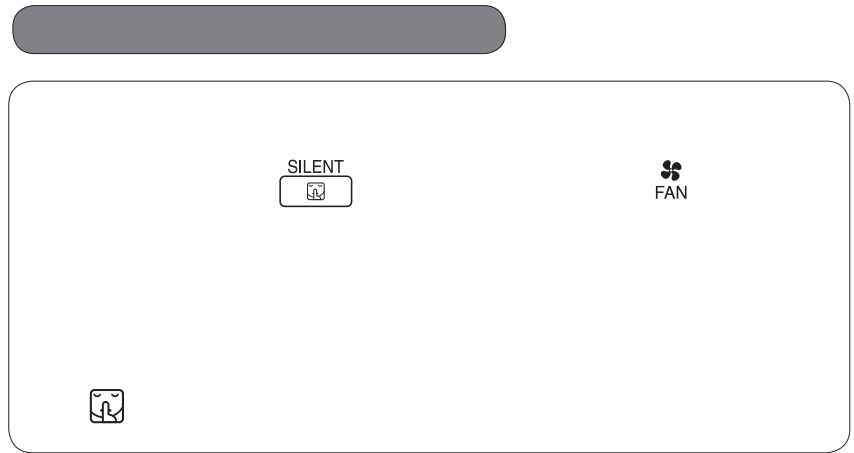
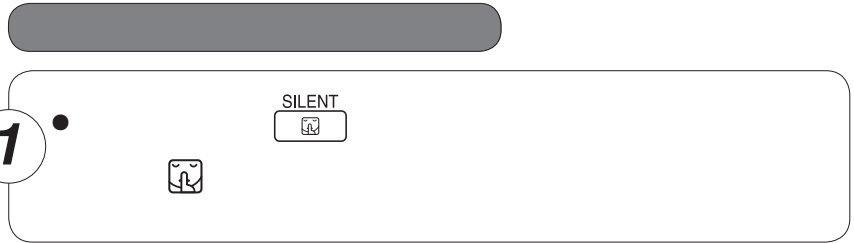

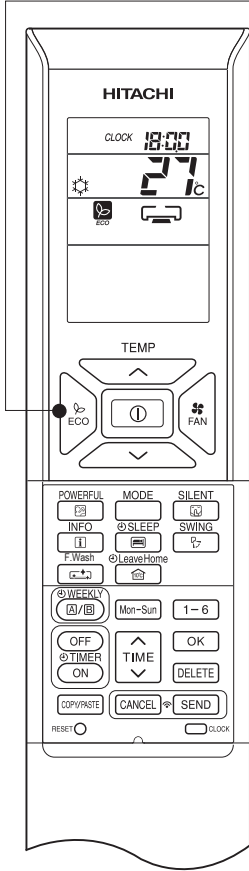

1

ECO



ECO



ECO



10°C

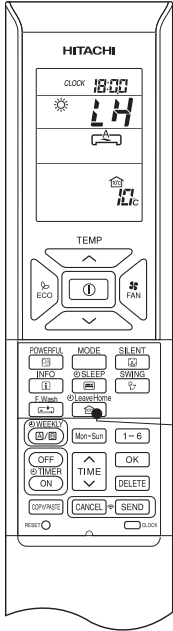

⊕ LeaveHome

☰

☀, "14", "A", "10°C"

⊕ LeaveHome

☰

☀, "14", "A", "10°C"

1

TIME

SEND

CANCEL

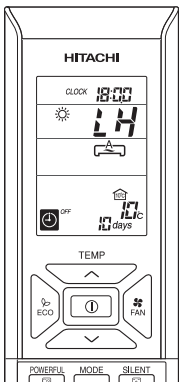

⊕ LeaveHome

☰

MODE



## РЕЖИМ САМОПОЧИСТВАНЕ (FROST WASH)

- Прахът и мръсотията, прилепнали към вътрешния топлообменник, което е причината за миризмата. Те се отмиват чрез замразяване и размразяване на топлообменника.
- Функцията Frost Wash може да работи, когато външната температура е от 1 °C до 43 °C, а влажността на закрито е 30% до 70%.
- Има два вида операция Frost Wash, автоматичен режим и ръчен режим.

### Frost Wash процедура

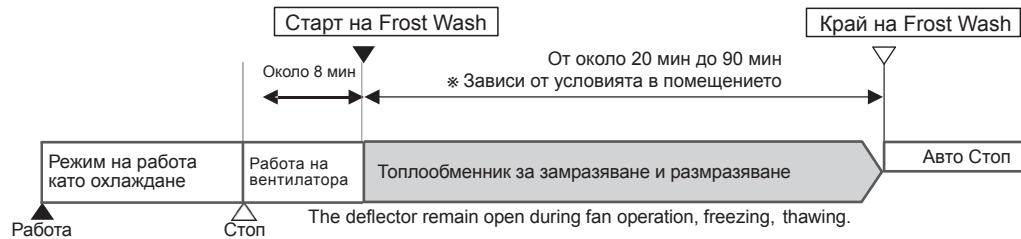

- "  " индикаторът на вътрешното тяло за режим Frost Wash ще свети.
- Ако искате да спрете режим Frost Wash, натиснете два пъти бутона (СТАРТ / СТОП).
- Ако по време на режим Frost Wash, натиснете бутон за избор на друг режим на работа, като например режим охлаждане, работата на функция Frost Wash се прекратява и уреда ще премине в избрания режим охлаждане след около 3 минути.
- Когато прекъснете функция Frost Wash, уредът автоматично ще започне отново режим Frost Wash при следващото спиране на работа.
- За да предпази продукта, производителят е предвидил, функцията Frost Wash да не може да се изпълни отново в продължение на около 60 минути след завършване на операцията Frost Wash.

### ■ Frost Wash (Автоматичен режим)

#### Frost Wash автоматични условия на стартиране

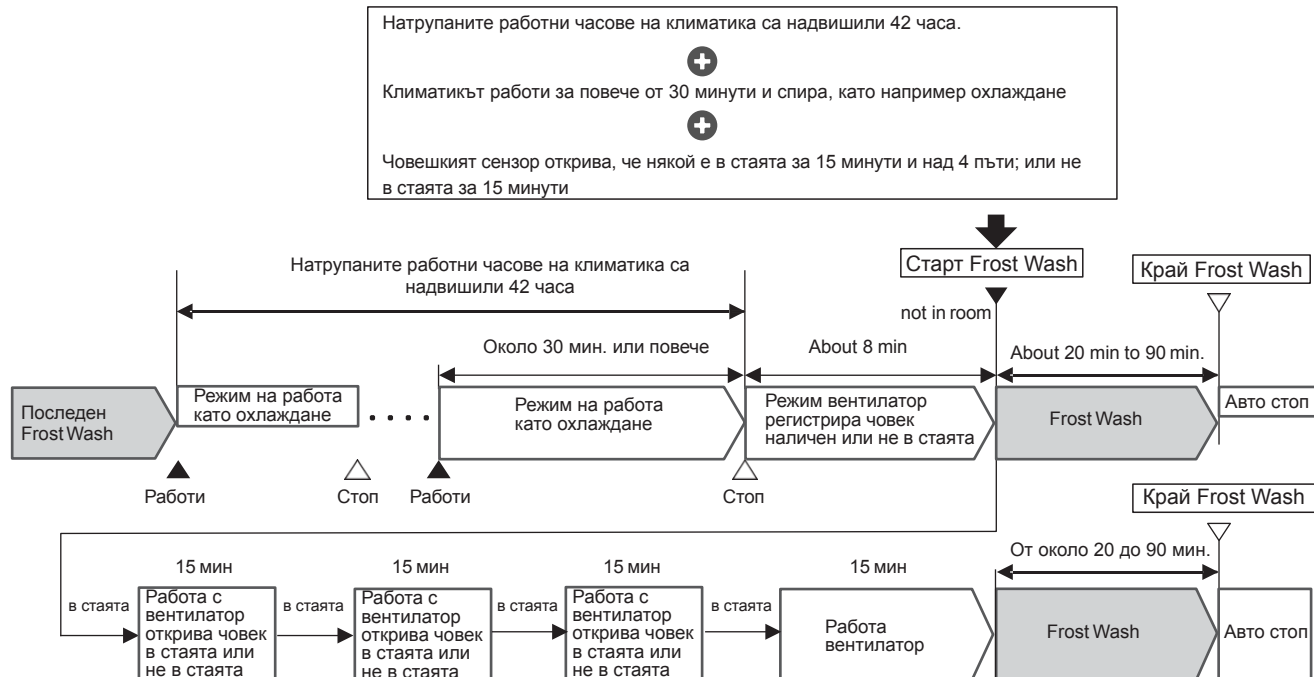

- Когато външната температура или влажността в помещението не са подходящи за режим Frost Wash, ще стартира само режим вентилатор. Режимът Frost Wash ще се извърши отново при следващото спиране на работа на работа.
- Понякога топлообменникът може да не замръзне в зависимост от условията в помещението.
- Когато таймерът за включване достигне зададеното време по време на работа на режим Frost Wash, той ще спре операцията Frost Wash и ще започне избрания режим таймер.
- Ако интервалът на таймера за изключване към включване е по-малък от 2 часа, операцията Frost Wash може да не бъде завършена. В този случай той ще рестартира режим Frost Wash при следващото спиране на работа.
- За да бъде нормален интервал Frost Wash (Автоматичен режим) (42 часа), моля, спрете работата на климатика и използвайте Frost Wash (автоматичен режим) или Frost Wash (ръчен режим).

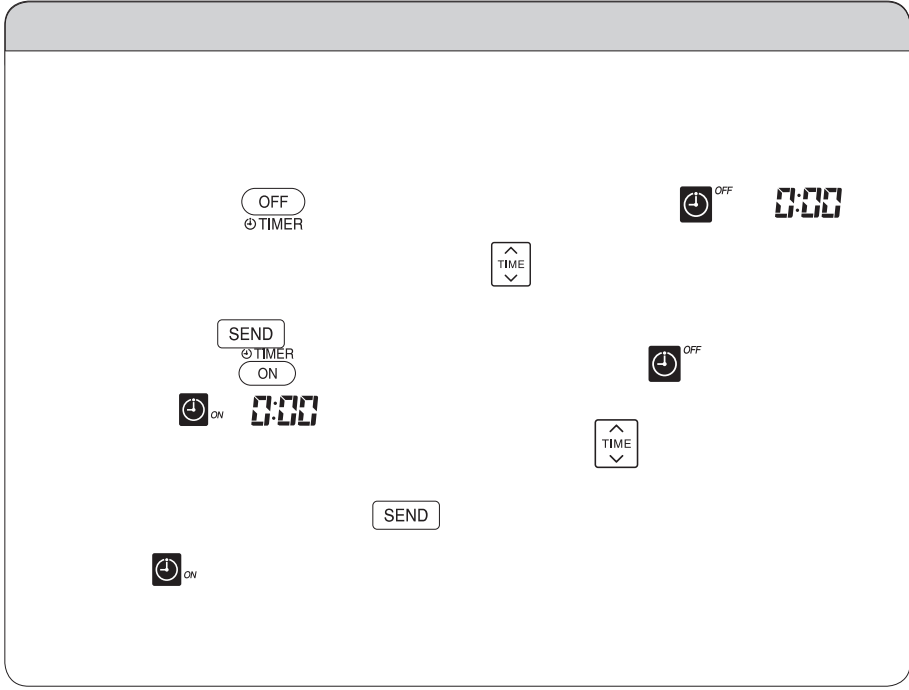
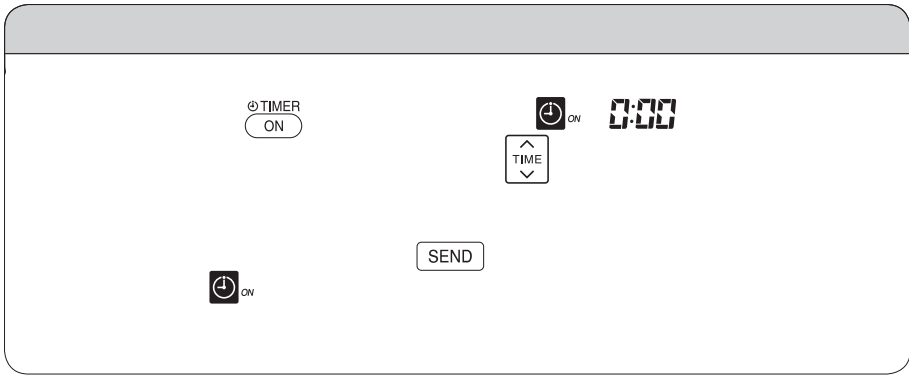
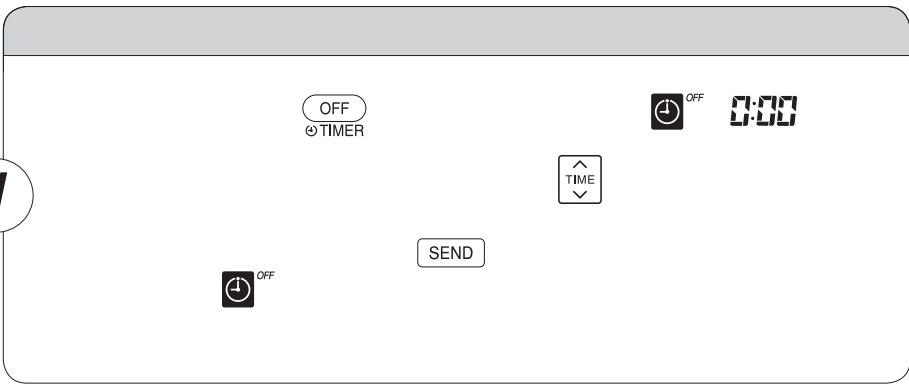
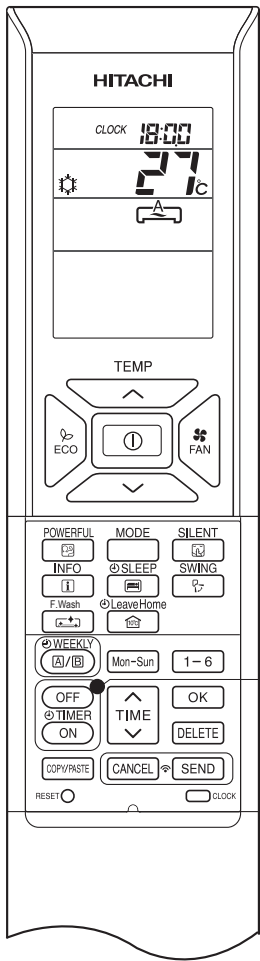

SLEEP

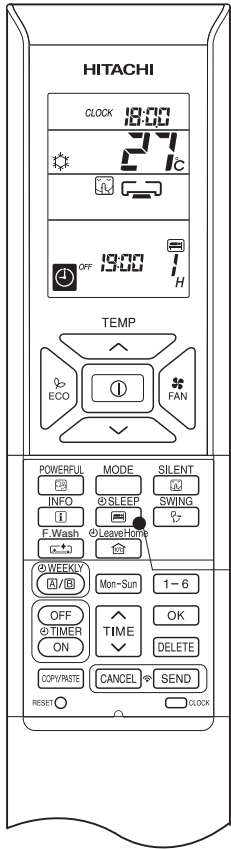

1

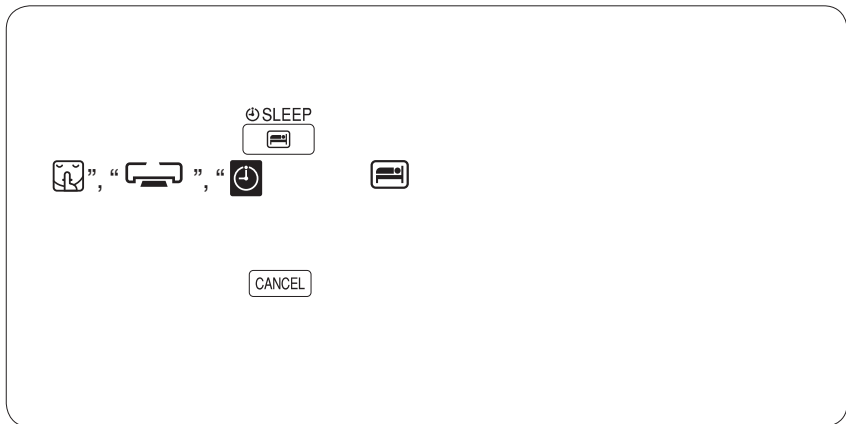
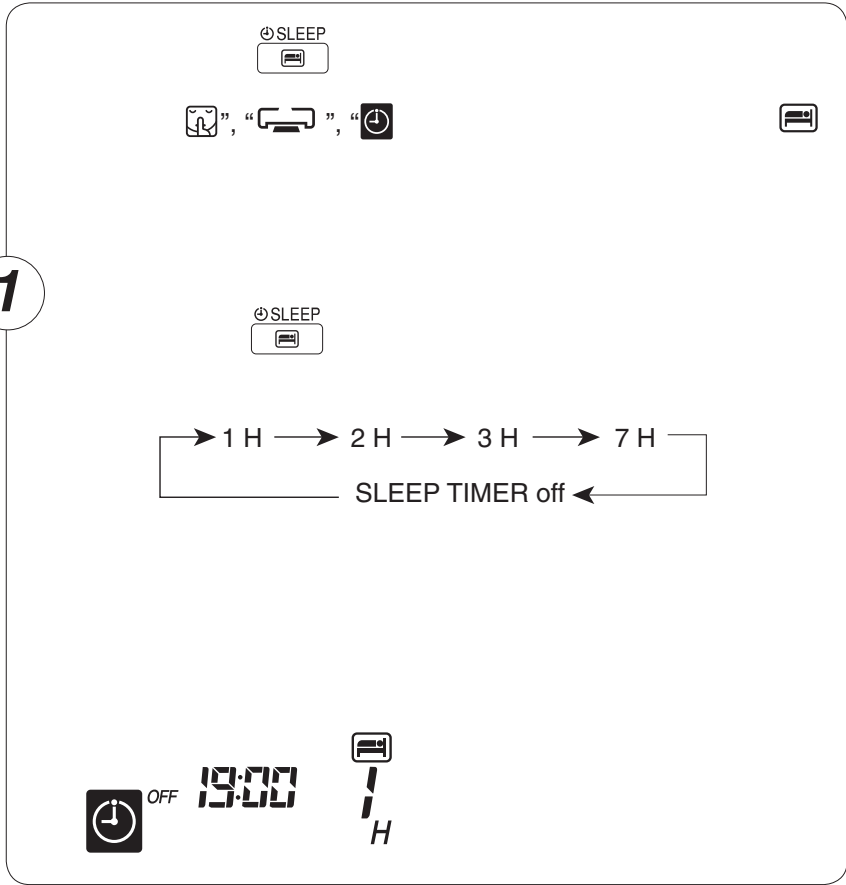

⊖ SLEEP

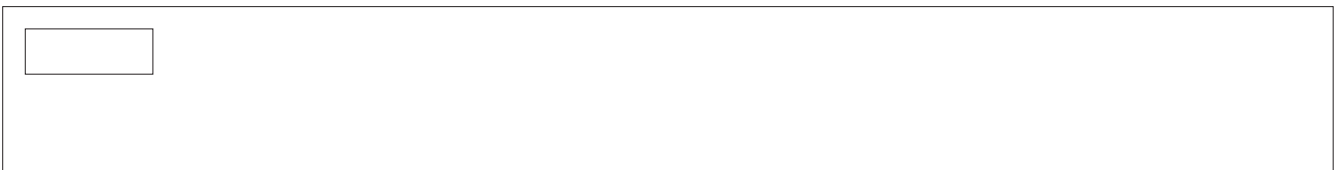
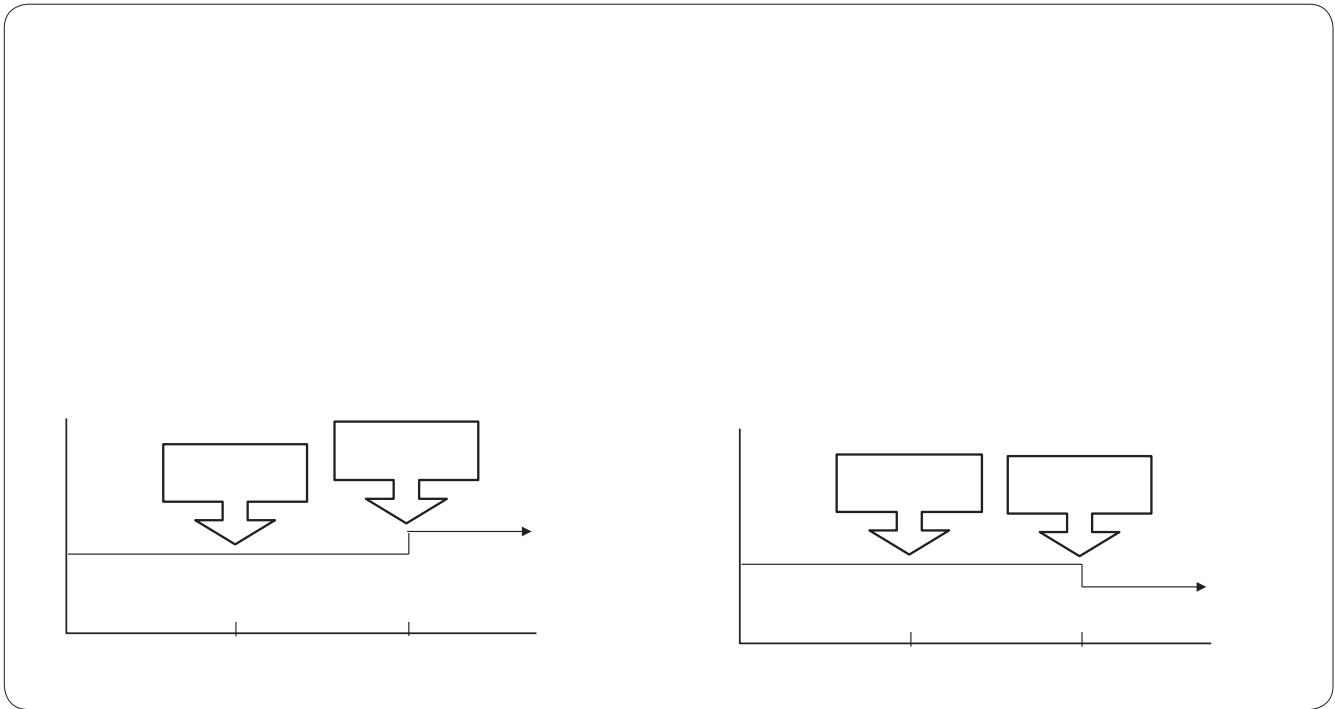
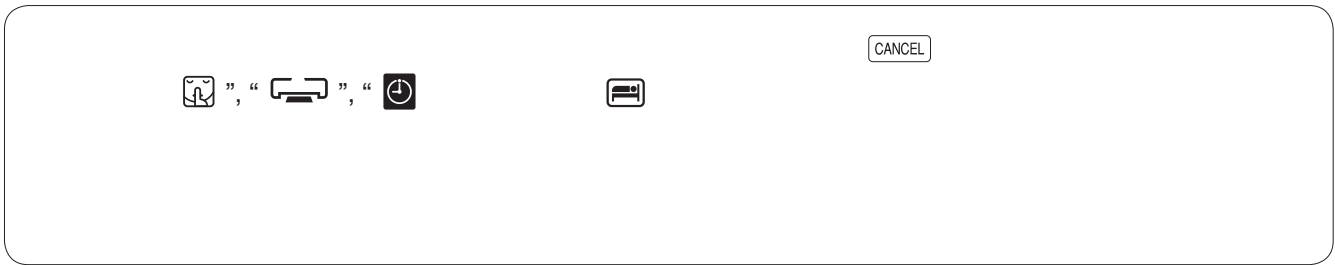
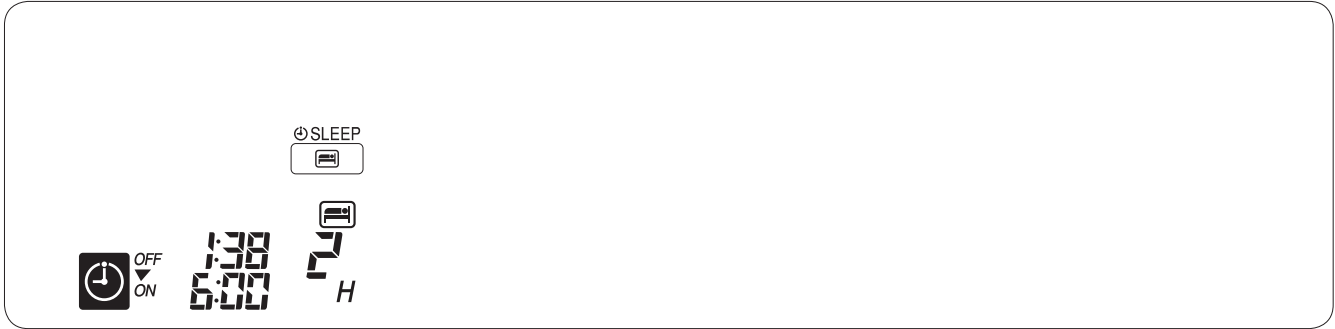

WEEKLY  
A/B

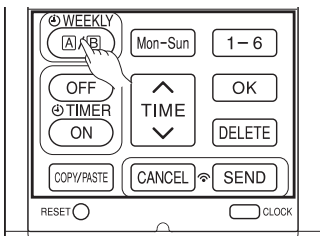
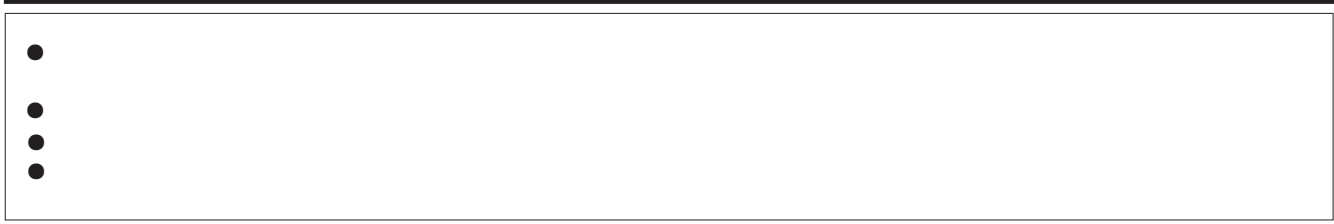

1

2

WEEKLY  
A/B

A



WEEKLY  
A/B

B

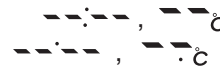

WEEKLY  
A/B

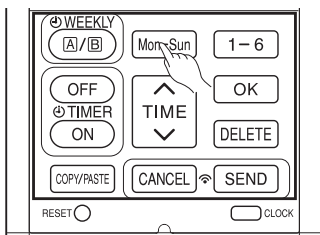

3

Mon-Sun

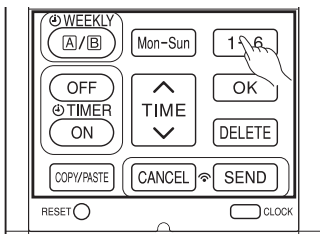
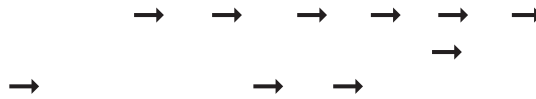

4

1-6





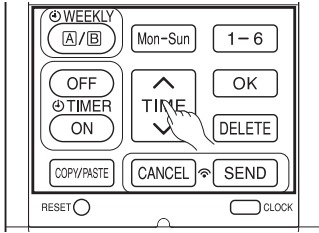
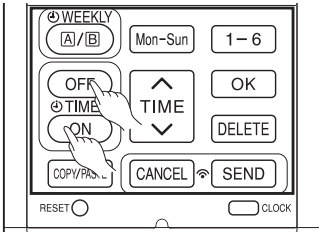

Mon-Sun

1-6



SEND

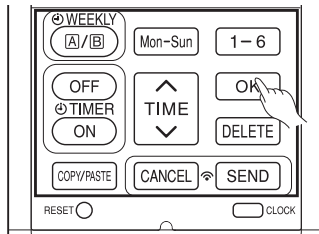
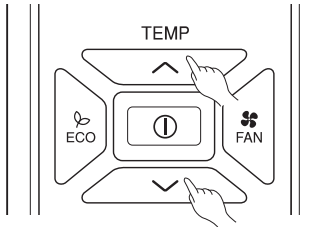

SEND

CANCEL

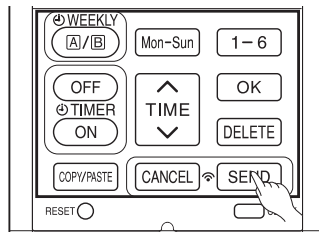

SEND



SEND

SEND

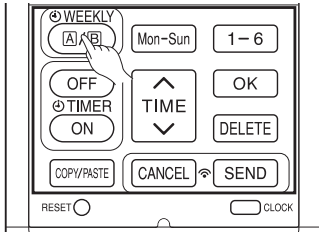

1  
2



SEND

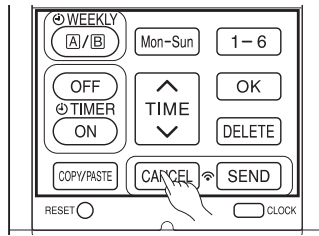
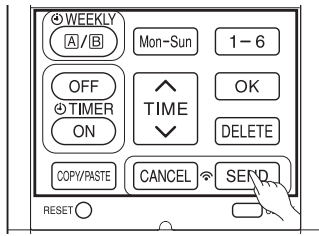

1

CANCEL

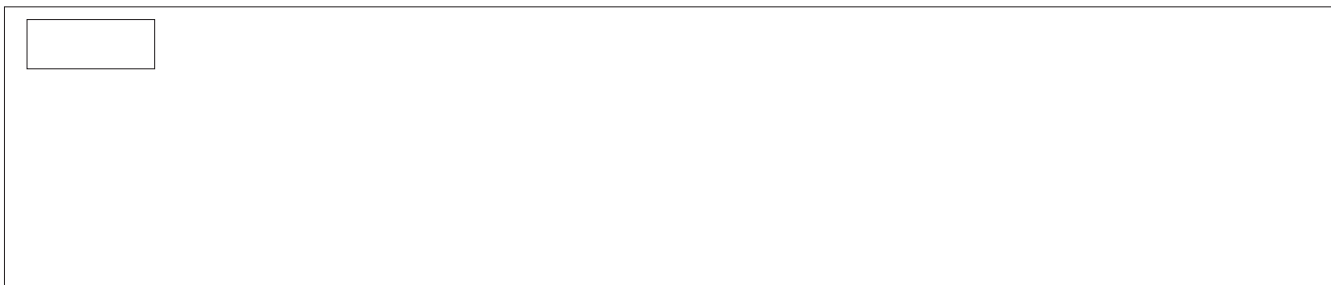

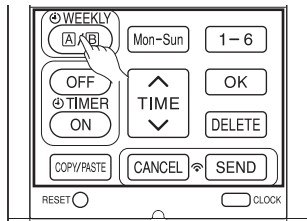

1

2

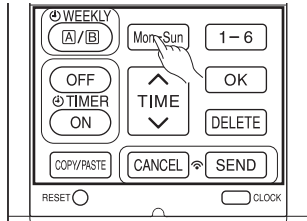

3

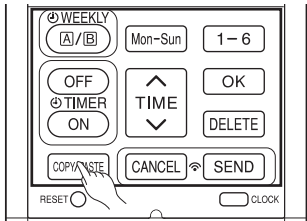

4

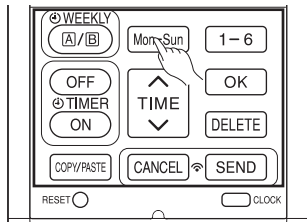

5

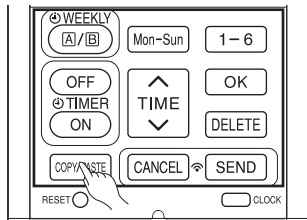

6

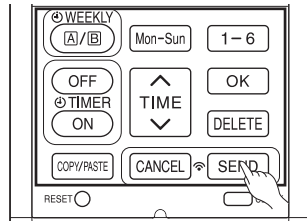

8



Mon-Sun

COPY/PASTE

CANCEL

Mon-Sun

COPY/PASTE



Mon-Sun

1-6



SEND

SEND

SEND



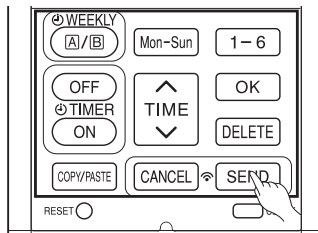
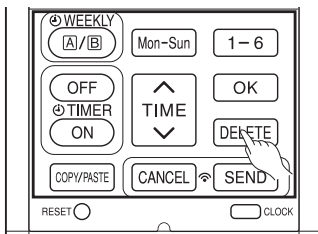
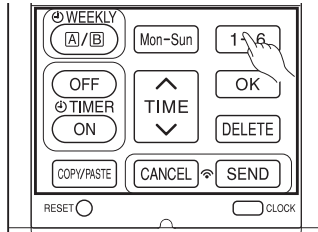
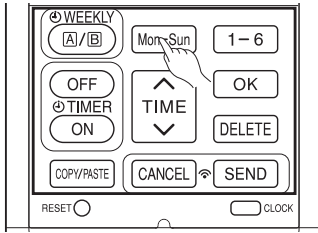
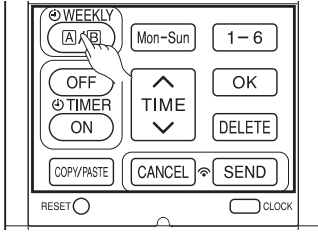
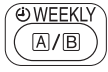

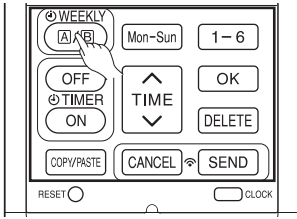

1  
2



Mon-Sun

DELETE

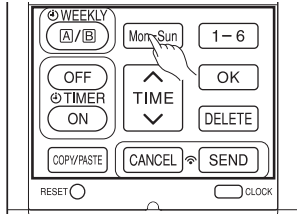

SEND

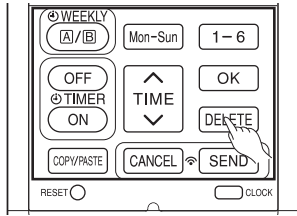

4

SEND

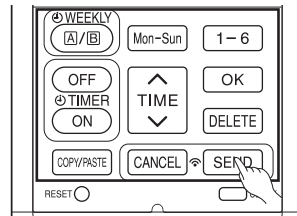

5

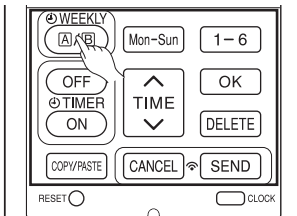

DELETE

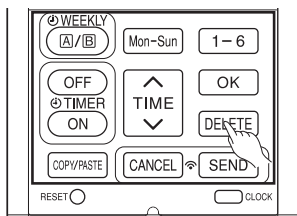

2



INFO



INFO



INFO

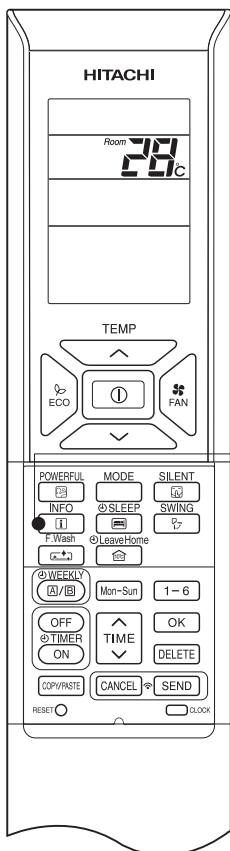

1



INFO

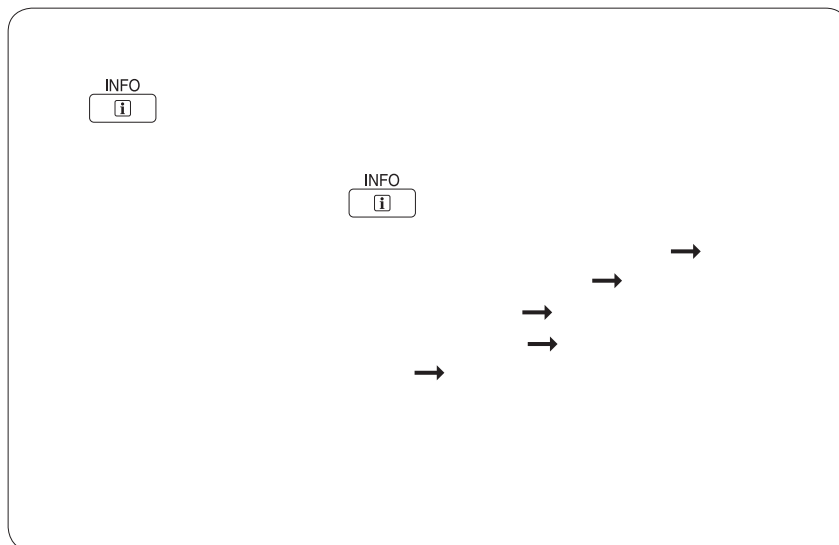

INFO



INFO

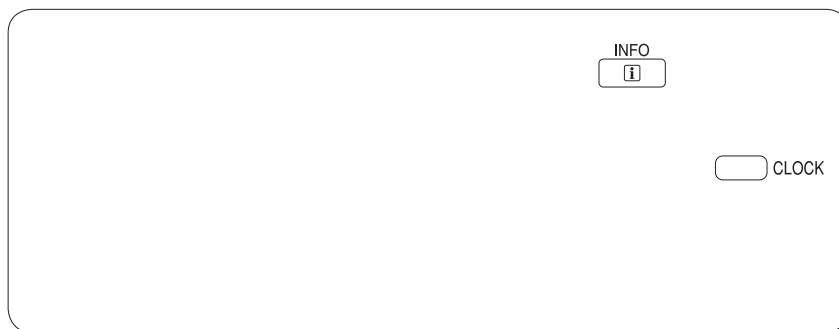

INFO



CLOCK

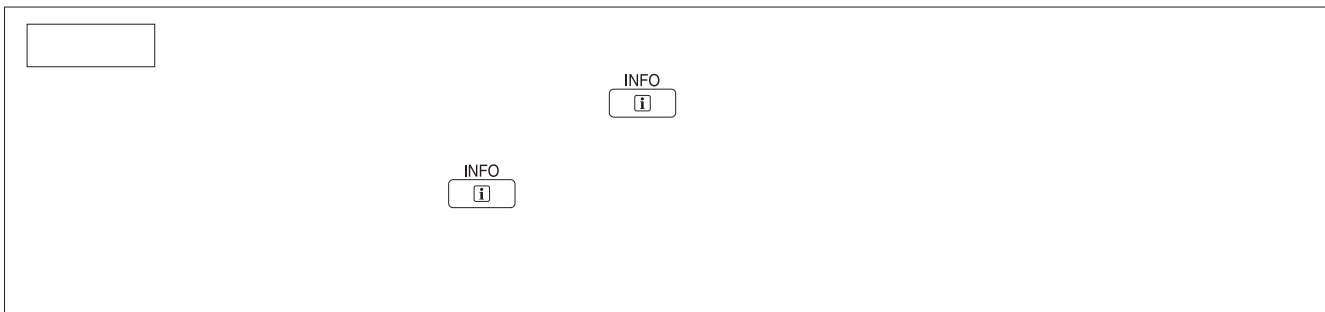

INFO



INFO



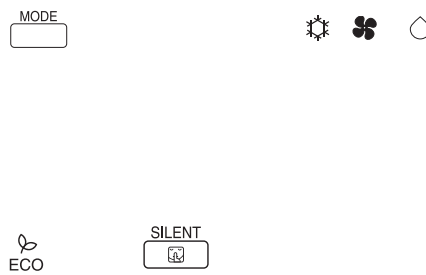
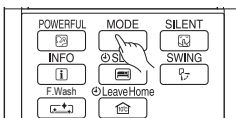
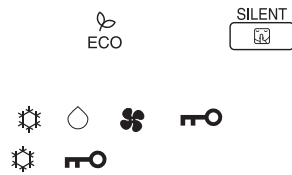
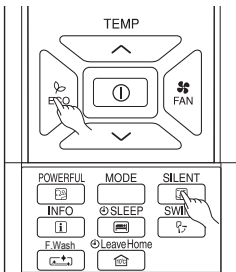
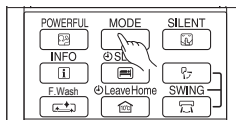
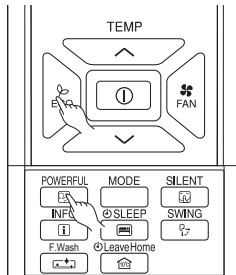

RESET ○

RESET ○

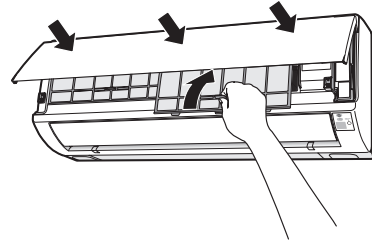
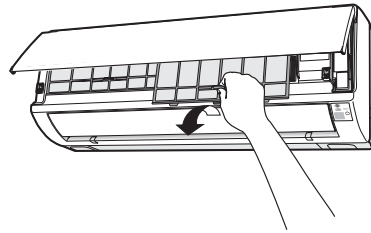
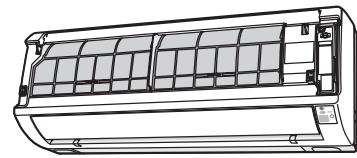



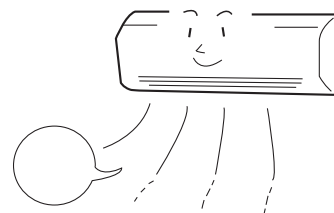
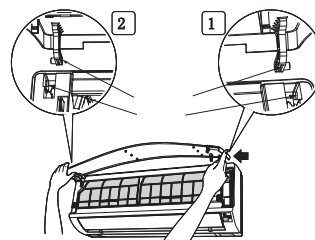
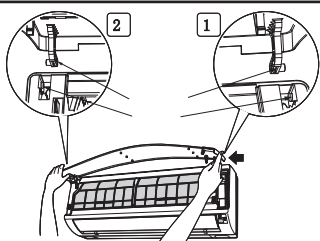
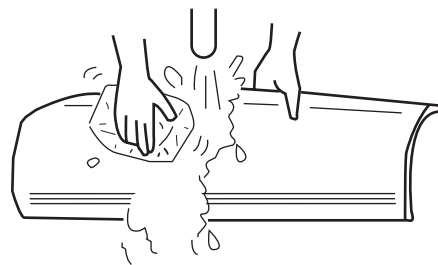

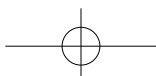
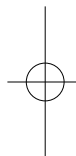
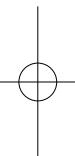
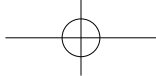

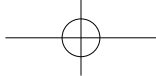

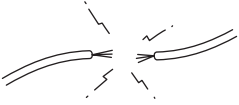

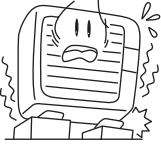



1			
2			
3			



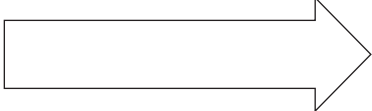
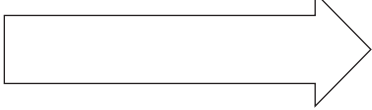
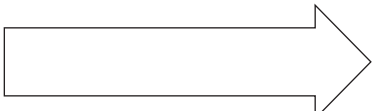

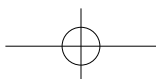
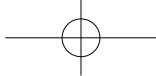

---